

USERS MANUAL

WIRELESS TILT METER

Model EAN-95MW



Doc. # WI 6002.116 Rev. 03 | July 2023



TUNNELS



HYDROELECTRIC



CONSTRUCTION



STRUCTURAL



METRO & RAIL



BRIDGES



MINING

CONTENT

1	INTRODUCTION	1
1.1	Wireless tilt meter overview	1
1.2	Tilt meter applications	1
1.3	Wireless network	1
1.4	Conventions used in this manual	2
1.5	How to use this manual	2
2	GENERAL DESCRIPTION	3
2.1	Model EAN-95MW wireless tilt meter	3
2.2	Model EWG-01 gateway	3
2.3	System components	3
3	TECHNICAL SPECIFICATION	4
4	PRE-INSTALLATION PREPARATIONS	5
4.1	Pre-installation checks	5
4.2	Selecting location for Gateway and Tilt meter	5
4.3	Setting up the Gateway & Tilt meter	5
4.4	Sampling Interval for Tilt meter node	5
5	QUICK START GUIDE	6
5.1	Gateway Setup	6
5.2	Tilt meter Node Setup	7
6	CONFIGURING TILT METER	8
6.1	Setting up Tilt meter	8
6.2	Connecting tilt meter to phone	9
6.2.1	Connection using Bluetooth	9
6.2.2	Connection using OTG	10
6.3	Config Node	11
6.4	System Setup	12
6.5	Sensor Reading	13
6.6	Download Data	13
6.6.1	File format	13
6.7	View Data	14
6.8	Upload File	15
6.9	Node Diagnostic	15
6.10	Factory Default	16
6.11	System Information	17
7	RE-CONFIGURING GATEWAY & NODES AFTER INSTALLATION	18
7.1	Re-configuring gateway via node	18

CONTENT

7.2	Re-configuring nodes via gateway	19
7.3	Re-configuration other nodes in same network via node	20
8	REGISTER NODE AT GATEWAY	23
9	INSTALLATION PROCEDURE	24
9.1	Tilt meter installation	24
9.2	Protection of tilt meter	24
9.3	Sign convention	25
9.3.1	Vertical plane	25
9.3.2	Horizontal plane	25
9.4	Environmental factors	25
10	TROUBLESHOOTING	26
10.1	Unable to connect Node over Bluetooth	26
10.2	Unable to connect Node with FTDI-OTG Cable	26
10.3	Unable to communicate with Gateway	26
11	SAFETY AND WARNINGS	27
11.1	Operation Safety	27
11.2	Battery caution & warning	27

1 INTRODUCTION

1.1 Wireless tilt meter overview

Encardio-rite model EAN-95MW wireless tilt meter is suitable for long term monitoring of inclination and vertical rotation of structures. Continuous data logging and real-time monitoring helps to provide early warning in case of impending failure allowing time for corrective action to be taken or if necessary for safe evacuation of the area.

Tilt change in a structure may be caused by construction activity like excavation, tunneling or de-watering that may affect the ground supporting the structure. Change in tilt could also result from loading of the structure, such as loading of a dam during impoundment, loading of a diaphragm wall during excavation or loading of a bridge deck due to wind and traffic. Data from the tilt meter provides early warning of threatening deformation of the structures.

1.2 Tilt meter applications

EAN-95MW wireless triaxial tilt meter is widely used in the following applications:

- Monitoring vertical rotation of retaining walls.
- Monitoring inclination and rotation of dams, piers, piles and other structures.
- Monitoring stability of structures in landslide areas.
- Monitoring tunnels for convergence and other movement.
- Monitoring safety of structures around zones of excavation or tunnelling.
- Monitoring deflection in bridges and struts under different loading conditions.

1.3 Wireless network

Wireless sensors are vital in monitoring construction sites, large structures and landslide areas. They are extensively used in applications where geotechnical and other sensors are used for data collection and transfer it to a central server for access by multiple users. Encardio-rite offers an innovative network solution that allows real-time monitoring of not only wireless tilt meter but also other geotechnical and structural sensors in challenging conditions with reliable data transfer without any delay.

In an end-to-end wireless monitoring system from Encardio-rite, the tilt meters are interfaced with the long range, low power radio frequency network to **gateway**. The tilt meter sends recorded data to the gateway through the RF network with utmost reliability. The gateway then uploads the collected data from sensors to the central/cloud server.

The system operates on ISM sub 1 GHz operating frequency bands adjustable to requirement of each territory. The system can be adjusted to different frequency bands; for example:

India	865 – 867 MHz
Europe	868 MHz
USA/Canada/Singapore/Australia	915 MHz

A detailed reference for frequency bands allowed in different Countries is available at:

<https://www.thethingsnetwork.org/docs/lorawan/frequencies-by-country.html>

The gateway also has provision to set the frequency band, depending upon the Country.

1.4 Conventions used in this manual

WARNING! Warning messages calls attention to a procedure or practice that if not properly followed could possibly cause personal injury.

CAUTION: Caution messages calls attention to a procedure or practice, that if not properly followed may result in loss of data or damage to equipment.

NOTE: Note contains important information and is set off from the regular text to draw the users' attention.

1.5 How to use this manual

This users' manual is intended to provide you with sufficient information for making optimum use of tilt meters in your applications.

To make the manual more useful we invite valuable comments and suggestions regarding any additions or enhancements. We also request to please let us know of any errors that are found while going through the manual.

NOTE: Installation personnel must have a background of good installation practices and knowledge of fundamentals of geotechnics. Novices may find it very difficult to carry on installation work. The intricacies involved in installation are such that even if a single essential but apparently minor requirement is ignored or overlooked, the most reliable of instruments will be rendered useless.

A lot of effort has been made in preparing this instruction manual. However best of instruction manuals cannot provide for each and every condition in field that may affect performance of the sensor. Also, blindly following the instruction manual will not guarantee success. Sometimes, depending upon field conditions, installation personnel will have to consciously depart from written text and use their knowledge and common sense to find solution to a particular problem.

Installation of a tilt meter requires expertise. It is recommended that potential users themselves practice all the operations laid down in this manual by repeated installations.

NOTE: The sensor is normally used to monitor site conditions and will record even a minor change that may affect behaviour of structure being monitored. Some of these factors amongst others, are, seasonal weather changes, temperature, rain, barometric pressure, nearby landslides, earthquakes, traffic, construction activity around site including blasting, tides near sea coasts, fill levels, excavation, sequence of construction and changes in personnel etc. These factors must always be observed and recorded as they help in correlating data later on and also may give an early warning of potential danger or problems.

2 GENERAL DESCRIPTION

2.1 Model EAN-95MW wireless tilt meter

Model EAN-95MW wireless tilt meter combines high precision Micro-Electro Mechanical System (MEMS) sensor with radio transmission network to provide accurate tilt data. The unit is mounted inside a compact weatherproof enclosure. The tilt sensor provides a 20-bits digital output proportional to the sine of tilt angle measured by the beam. The sensor can measure tilt in all the 3-axes (X, Y and Z). Tilt sensor measurement range is $\pm 30^\circ$. The output of any axis is zero for a truly horizontal position. The unit has a built-in thermistor to measure temperature. Temperature is measured using 24-bit ADC which provides accurate temperature within $\pm 0.1^\circ\text{C}$.

The measured values are transmitted through the long range, low power radio frequency network to the gateway without any signal degradation. Each unit is individually calibrated to provide high system accuracy and repeatability.

The model EAN-95MW tilt meter measures change in tilt of a structure to which it is attached. The tilt meter can be fixed to any vertical surface, horizontal floor or ceiling by means of suitable mounting accessories consisting of anchors (and brackets – optional). These are available separately when ordered.

2.2 Model EWG-01 gateway

Encardio-rite model EWG-01 wireless gateway is used as a main networking hardware, which uploads data gathered from all the tilt meters (or other geotechnical sensors) to the remote server. The gateway enabled with wireless network provides reliable data transfer over long distances, without any delay. The wireless system eliminates the need for running lengthy cables. This is especially useful at locations where sensors are distributed over a wide area and running cables to long distances can be tricky and risky.

The data is accessible 24 x 7 to all the stakeholders. With Proqio, a cloud-hosted data management and configuration software, the system can be programmed to generate automatic reports and provide automated alerts over SMS or email for any reading crossing the pre-defined alert levels.

With the real-time data collected from wireless tilt meters and gateway, information about the slightest of change taking place at specific location is available. This allows timely decisions, increased safety and cost effectiveness.

2.3 System components

Provided by Encardio-rite:

- Model EAN-95MW- Wireless tilt meter with antenna
- Model EWG-01 Gateway with antenna
- Gateway and Node mounting accessories
- RS-232 Bluetooth modem/USB to RS-232 FTDI cable
- Application software for Android Smartphone
- Application software for Windows

To be arranged by Client:

- Laptop or Android Smartphone
- Activated data SIM card – 1 no. for Gateway
- D-Cell Li-SOCI2 3.6 V 14.5 Ah batteries - 4 no (2 no. each for tilt meter and Gateway)
- Power supply unit 9-30 V, 1 A for Gateway (12 V, 1 A power supply easily available can be used)

3 TECHNICAL SPECIFICATION

Basic			
Internal Battery	2X3.6V Li-Ion Battery (D-cell ER34615M)		
External Power	9V Standard adaptor or EBS-01(available on order)		
Operating Current	25 mA (max)		
Dimension	120X100X81(LXWXH) without antenna 159X100X187(LXWXH) with antenna		
Weight	0.807 Kg (Without Battery) 1.0045 Kg(With Battery)		
Storage	3 Million data points		
Primary Sensor			
Sensor Type	MEMS Accelerometer		
No. of axis	3-Axes (X, Y and Z)		
Accuracy	± 0.1% FS		
Resolution	20 bit		
Sensitivity	± 10 arc seconds		
Range	±30 deg		
Temperature Sensor			
Sensor Type	3K thermistor		
Accuracy	0.1°C		
Range	-20°C to +70°C		
Enclosure			
Material	Aluminium-Alloy Die casting 12(Epoxy Polyester Powder Coating)		
IP Rating	IP-65(IS-60947 Part-1:2004)		
Fire Proof	Approved		
Protocol			
ER Protocol	Proprietary Encardio Protocol		
Radio			
LoRa Chipset	SX1276		
Frequency	EU	US	ROA
	863-870 MHz	902-928 MHz	920-928 MHz
Transmit Power	863-870 MHz (EU)	902-928 MHz(US)	920-928 MHz(ROA)
	14 dBm	20 dBm	20 dBm
Baud Rate	9600 bps(Max)		
Receiver Sensitivity	-132 dBm		
Transmission Distance	(1 ~ 15 KM)*		

* 800 meter in urban areas

4 PRE-INSTALLATION PREPARATIONS

4.1 Pre-installation checks

- Before installation please check the tilt meter and gateway for any physical damage.
- Open the tilt meter and gateway box to check if the internal wirings are intact.

4.2 Selecting location for Gateway and Tilt meter

Selecting correct locations for Gateway and tilt meter is important, especially in case more than one tilt meter are being installed at site and connected to single gateway.

The first step is to install the Gateway at a location that is in line of sight with all the installed tilt meters or in line of sight with most tilt meters. The best location will have to be determined at the site itself. For best results, the link between the gateway and the tilt meter should be strong, preferably better than -100 dBm. Please note, the stronger the link better will be the results.

4.3 Setting up the Gateway & Tilt meter

It is recommended that the setting up and configuration of tilt meter and gateway is done before mounting the sensors and gateway at respective installation location.

The gateway configuration needs to be done before tilt meter. For setting up and configuring the gateway, refer to User's Manual # WI6002.117 on Gateway. Configuration of tilt meter is discussed in Section 6 of this manual.

For convenience, a "Quick Start Guide" is included in Section 5 to give a brief and quick idea.

4.4 Sampling Interval for Tilt meter node

When configuring the Encardio-rite wireless system, it is crucial to select appropriate sampling intervals to ensure the network operates smoothly without any data loss. The table below provides guidance on sampling interval selection based on the network size.

The wireless tilt meter (RF) with in-built node:

Number of nodes	Minimum Sampling interval (Minutes)
1	4
10	7
50	20
100	37
150	53
200	70

The General formula to calculate Sampling interval for Tilt meter node is:

$$\text{Sampling Interval (Seconds)} = (20 * \text{No. Tilt meter Node}) + 180$$

Please note that these recommended sampling intervals serve as general guidelines. Depending on specific project requirements, environmental conditions, and data collection needs, adjustments to the sampling intervals may be necessary. It is advisable to consult with the Encardio-rite technical support team for further guidance on fine-tuning the sampling intervals for your particular network setup.

5 QUICK START GUIDE

5.1 Gateway Setup

Use step by step procedure to configure the gateway.

- Step 1:** Open the gateway box. Insert the 4G Sim card. Connect both the antenna's into their respective connector.
- Step 2:** Insert the battery into battery holder with their correct polarity.
- Step 3:** Connect any standard DC Power (9-30 V, 1 A) into Connector named as "IN" on the PCB with correct polarity.
- Step 4:** Switch on the Gateway and wait for 1 minute.
- Step 5:** Install the EWA-01 apk file (provided with supply) into android phone and allow all the permissions asked during apk installation. After installation close the application.
- Step 6:** Go to android phone's Settings>>Connections
- Step 7:** Turn ON the Smartphone Bluetooth
- Step 8:** Press on [Scan](#) option to search nearby Bluetooth devices
- Step 9:** Press on "[EWG-01 Serial Number](#)" found from the scanned device list. Gateway serial no. is written on the PCB.
- Step 10:** Pair the Gateway with Android phone using passkey = [6982698076](#)
- Step 11:** Now open EWA-01 application on Android phone
- Step 12:** Select the paired Gateway to connect the application with gateway.
- Step 13:** Once connected go to [Config Gateway >> Edit](#)
Enter Gateway ID, Installation date and select Network ID, Frequency plan
Enter Latitude and Longitude information either manually or through map.
Note down the Network ID.
Click on [save](#) button.
- Step 14:** Go to [Cellular Setup>>Turn on modem](#) to check for the signal strength then >>[Turn off modem](#)
Go to [EDIT](#) enter the FTP credentials for data upload and then [UPDATE](#)
Go to [EDIT](#) enter the FTP credentials for two way communication and then [UPDATE](#)
Enter [APN](#) of the network service provider and [UPDATE](#)
Click the [FTP TEST](#) tab to verify the communication between Gateway and FTP server
- Step 15:** Go back to previous screen and Click on [Scheduler Setup>> Update Date/Time or Sync with Phone](#) to set the clock of the gateway.
Click on the [Erase Gateway Memory](#) to erase residual data if any.
Configure the [Next Scan start time](#) and [scan interval](#) by clicking on the clock icon's provided in line with them and then [update](#). Go back to the home screen and press the back button to disconnect the gateway from mobile phone.
With this, the basic configuration of gateway is completed. Now we will move forward to configure the node.

5.2 Tilt meter Node Setup

Use step by step procedure to configure the Tilt meter Node.

Step 1: Open the tilt meter box. Connect the RF antenna (Provided with supply).

Step 2: Insert the batteries into battery holder with their correct polarity.

Step 3: **Optional** - Connect any standard DC Power (9V, 1A) into Connector named as "EXT" on the node PCB with correct polarity.

Step 4: Switch on the tilt meter and wait for 30 sec.

Step 5: **Connecting the tilt meter to phone:**

1. Through Bluetooth Modem

- Insert the RS-232 Bluetooth Modem (provided with supply) into DB9 connector and switch on the Bluetooth modem
- Go to android phone's [Settings>>Connections](#)
- Turn ON the Smartphone Bluetooth
- Press on [Scan](#) option to search nearby Bluetooth devices
- Press on "[ERB-01 Serial Number](#)" found from the scanned device list. Node serial no. is written on the PCB.
- Pair the Node with Android phone using passkey = [6982698076](#)
- Now open EWA-01 application on Android phone
- Select the paired Node to connect the application with Node.

2. Through RS-232 –USB-OTG Cable

- Switch on the tilt meter node and connect it to the Smartphone using the FTDI to OTG adaptor provided with supply. Once connected a prompt window will appear. Tap the FTDI button, Home screen of tilt meter node will appear. Refer to the section 6.2.2 of this users manual for more details on this.

Step 6: Once connected through any one methods explained in Step 5 go to [Config Node >> Edit](#)
Enter Node ID, Installation date and select Network ID (same as Gateway network Id), Frequency plan(Same as selected in Gateway).

Enter Latitude and Longitude information either manually or through map. Click on [Save](#) button.

Step 7: Go to [Node Diagnostic >> Start Test](#) to see the signal strength and test packet status and then [Stop test](#).

Step 8: Go back to previous screen and Click on [System Setup>> Update Date/Time or Sync with Phone](#) to set the clock of the node.

Click on the [Erase Node Memory](#) to erase residual data if any.

Click on the [Edit](#) under Edit Sensor Parameter to enable/disable the parameter to report along with their units of choice, click on [Save](#).

Step 9: Go back to previous screen and click on [Sensor Reading >>Start](#) to monitor the parameters selected in step 8. After monitoring click on the [>> Stop](#).

Step 10: Go back to Home screen click on [Register Node at Gateway](#) and wait for some time. If everything has been followed as per the steps stated above the node will successfully registered to the gateway.

With this, we have completed the basic configuration of Encardio-rite wireless systems. User can close the box.

6 CONFIGURING TILT METER

6.1 Setting up Tilt meter

- Open the top cover with screw driver. Description of each part of the tilt meter is given in the figure 6-2.

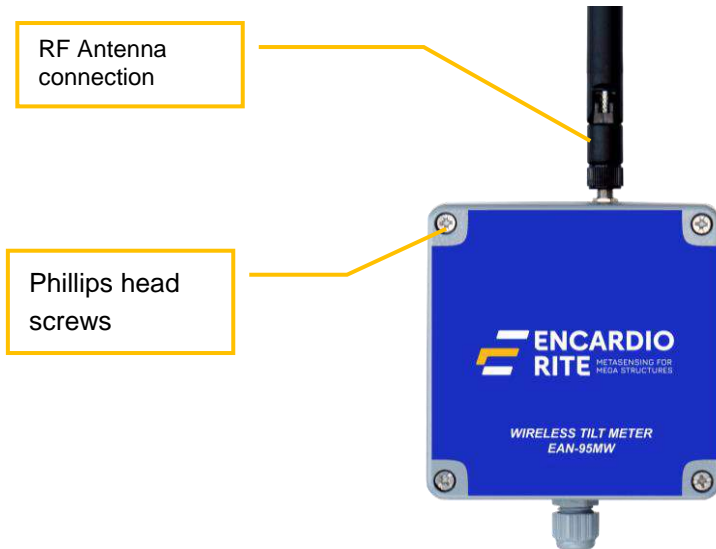

Figure 6-1

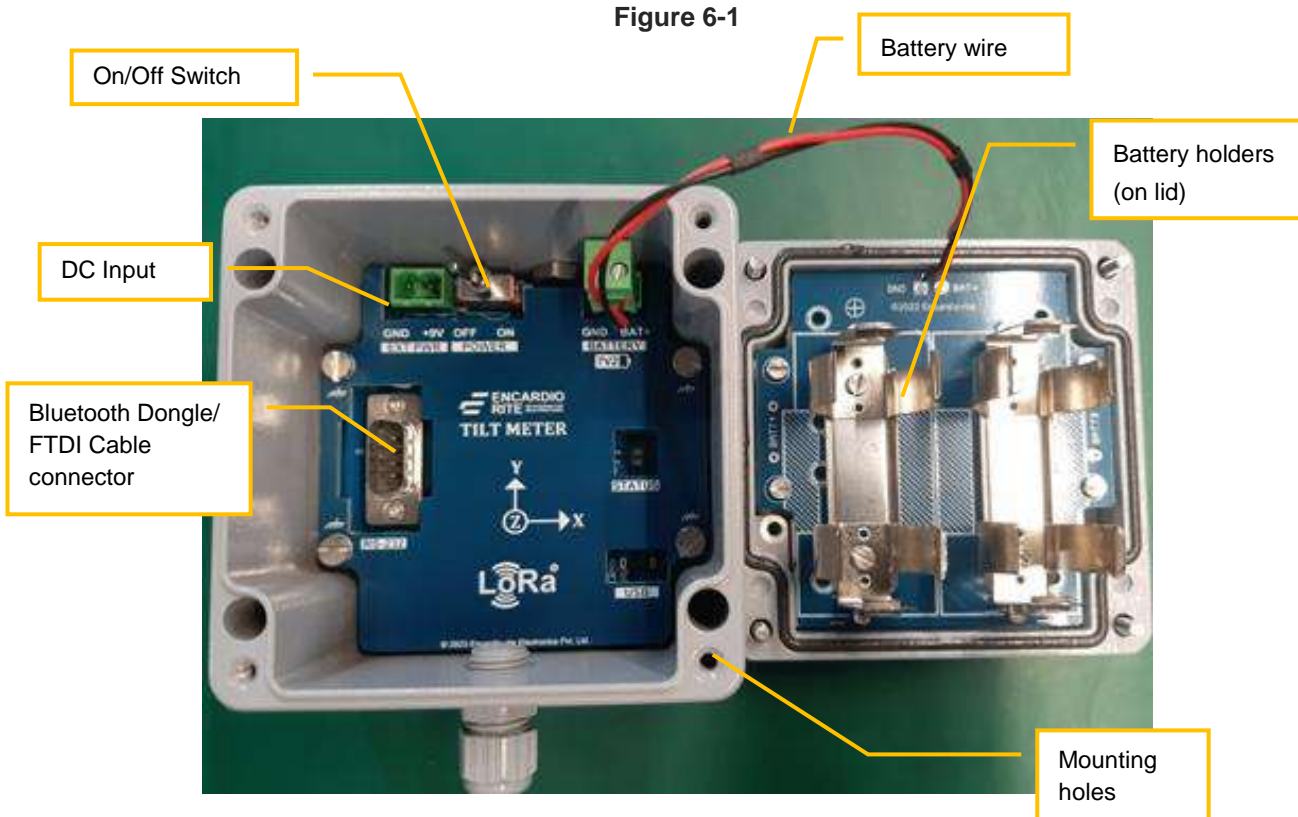

Figure 6-2 Wireless tilt meter details

- Connect the RF antenna (provided with supply) to the tilt meter properly.
- Insert the batteries carefully into Battery holder with their correct polarity. Ensure that the positive “+” and negative “-” are correctly connected, then switch on the node.
 - In case fast scanning is required, connect any standard DC power adaptor (9 V, 1 A) to “DC Input”.
 - Or, Encardio rite make solar battery charger can also be used (available against order).
- After power up, wait for 30 seconds as during this time tilt meter performs internal operations.

6.2 Connecting tilt meter to phone

Install the apk file (provided with the supply) for “EWA-01” app on the phone. App shortcut will be available in the list of application software, as shown in figure 6-4 (a). Open the application and allow all the permissions required for proper functioning.

6.2.1 Connection using Bluetooth

The tilt meter node can be connected with mobile by using Bluetooth. Plug Bluetooth modem (provided with supply) at 9 pins D-sub connector of the Node. Make sure that modem must be configured for 115200 baud rate and hardware flow must be OFF. Verify DIP switch settings with following figure 6-3.

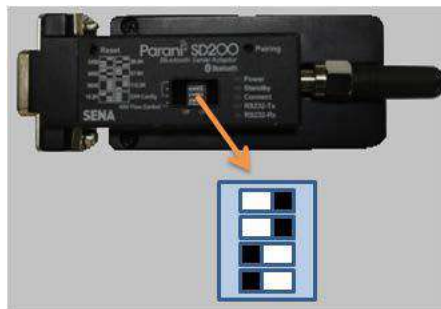
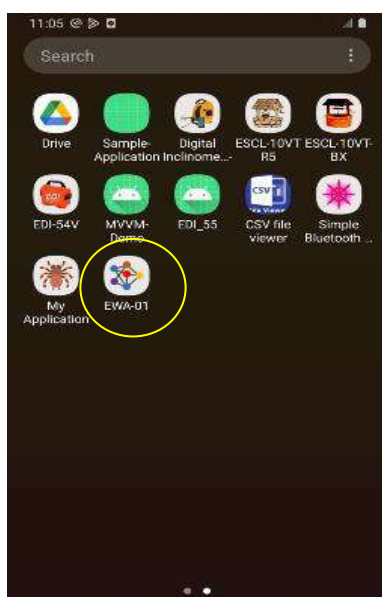
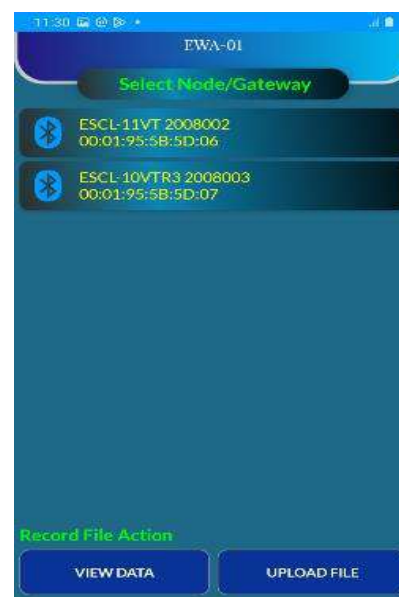

Figure 6-3: Bluetooth modem DIP switch settings

- Turn-on the Bluetooth modem by pressing ON/OFF switch located near modem’s battery compartment. The power indicator of Bluetooth modem will glow in GREEN color to ensure that Bluetooth modem is ON.
- Turn on Bluetooth of the android phone and go to Bluetooth settings. Click on “scan” button. Phone will show the list of Bluetooth devices found. Find the Node Name and serial number on phone screen and click for pairing the phone with Node. Once pairing button is pressed it will ask to enter passkey for authentication.
- Enter pairing code “6982698076” and then press OK. On successful authentication, it will show that device is paired. Now phone is paired with Node.



(a)



(b)

Figure 6-4

- Open the “EWA-01” apk installed on phone. It will show the list of paired Nodes as shown in the figure 6-4 (b). Select the node paired from the list. It will take you to the home screen of the node as shown in figure 6-6 (b).

6.2.2 Connection using OTG

- Switch on the tilt meter node and connect it to the Smartphone using the FTDI to OTG adaptor provided with supply, as shown in figure 6-5 below.

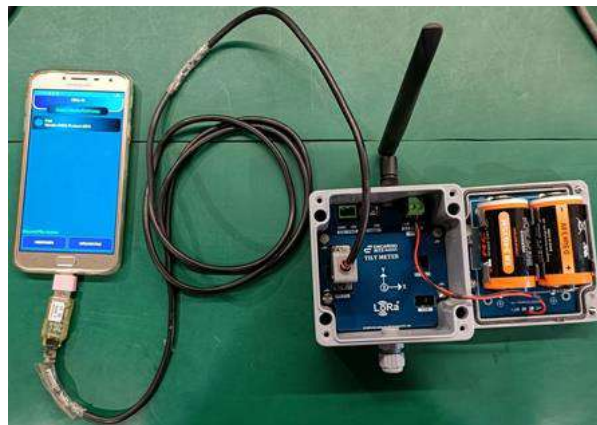
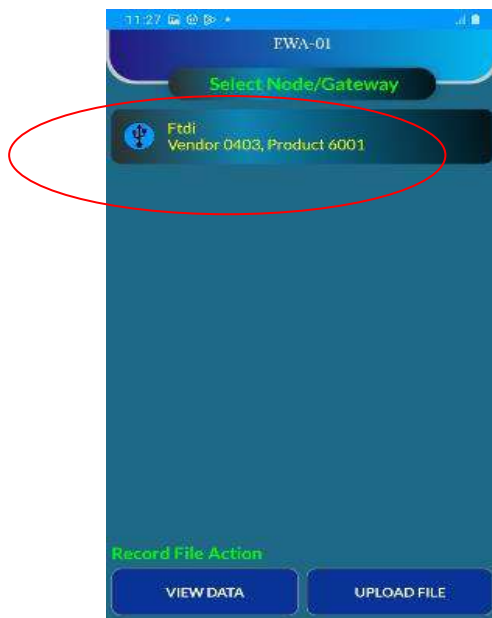

Figure 6-5 Tilt meter connected to Android phone with FTDI cable via OTG adaptor

- Once connected a prompt window will appear as shown in the figure 6-6 (a). Click on the FTDI button, Home screen of tilt meter node will appear, as shown in figure 6-6 (b).
- At the home screen, various information about the node can be seen. Detailed description of each segments required for configuration is given in the subsequent sections.



(a)



(b) Home Screen

Figure 6-6 Home screen

6.3 Config Node

- Click on the “CONFIG NODE” tab from Home screen, a window as shown in the figure 6-7 (a) will appear. Click on ‘Edit’ button to input the information as per the requirement.



Figure 6-7 Config node

- User can input the “Node ID” of their choice. Try to input some meaningful ID so that it becomes convenient for other users also.
- Click on the Calendar Icon as shown in figure 6-7 (b) to enter the “Node Inst. date”.
- User can select the “Network ID” from the drop down menu. Select the same Network ID what was selected during Gateway configuration.
- Select the “Frequency Plan” from the drop down, as was selected for gateway. This depends on the installation location, to comply with the local regulations. User can select the region and associated frequency by tapping on the search icon.
- For setting Latitude and Longitude of respective installation location, click on the location icon as shown in figure 6-7 (b). A prompt window will appear as shown in figure 6-8 (a)
 - If user knows the installation location coordinates, select the button “Set location manually” and enter the Latitude and Longitude information as shown in figure 6-8 (b). Click on “OK” to set the coordinates manually.
 - If user does not know the installation location coordinates, select the button “Set location from map” for automatic location setup. This needs to be done at the installation site location only. Ensure that the internet connectivity is there in the phone during this process. Once location is selected, click on the “SAVE” button to store all the information inside node.

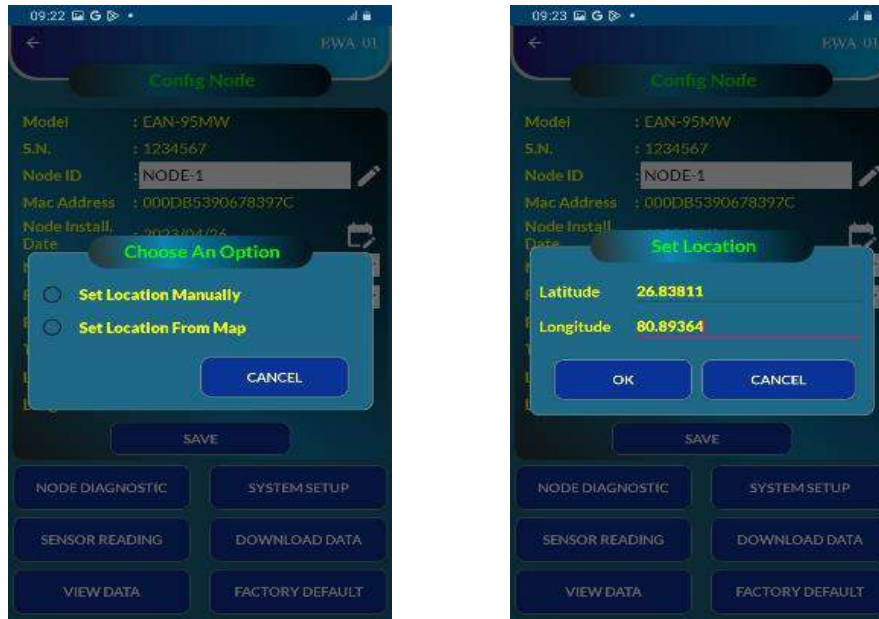

(a)

(b)

Figure 6-8 Location Coordinates

6.4 System Setup

Clock and parameter related information can be edited and modified under system setup.

- Tap the “SYSTEM SETUP” button from “Config Node” screen (figure 6-7 (a)). A new window will appear as shown in figure 6-9.



Figure 6-9 System Setup

- Set the “Clock Settings” either manually or through auto sync option. Remember that during auto synchronization, the smart phone must have the updated RTC clock settings.
- Any previous log can be erased by clicking on “ERASE NODE MEMORY”. Be cautious while doing so as erased data cannot be recovered later.
- User can also control and configure the parameter along with their units of choice. Just tap the “EDIT” button, do the configuration and save the changes through “SAVE” button.

6.5 Sensor Reading

Live reading of all the parameters selected under “system setup” can be seen through “Sensor Reading”. Live readings will help during installation of the node.

- Tap the “SENSOR READING” tab from “Config Node” screen (figure 6-7 (a)) to see the live readings of tilt and temperature. Screens as shown in figures 6-10 (a) & (b) will appear.



Figure 6-10 Sensor reading & Download data

6.6 Download Data

- Press “Download Data” button from “Config Node” screen (figure 6-7 (a)). A window as shown in figure 6-10 (c) will appear. Two options are provided to download the data:

- Since Beginning
- Since Last Download

Select the first option if data is downloaded for the first time otherwise select the second option.

- Click on the “DOWNLOAD & SAVE FILE” tab to start downloading the data. A progress bar will appear to display the download progress. Data download time depends on records size. After successful download, an information window pops-up indicating the successful download.

6.6.1 File format

The downloaded data format from the tilt meter node is as shown below:

```
"NODE ID","DATE/TIME","BATTV(INT)","BATTV(EXT)","AXIS-X(Sin A)","AXIS-Y(Sin A)","AXIS-Z(Sin A)","TEMP(deg C)"
"RF-TILT-1","2023/06/13 12:22:57",7.24,0.00,-0.0043,-0.0001,-0.2595,-12.87
"RF-TILT-1","2023/06/13 12:29:01",7.23,0.00,-0.0045,0.0002,-0.2595,-12.99
"RF-TILT-1","2023/06/13 12:35:01",7.23,0.00,-0.0045,0.0002,-0.2595,-13.09
"RF-TILT-1","2023/06/13 12:41:01",7.23,0.00,-0.0044,0.0002,-0.2595,-13.17
"RF-TILT-1","2023/06/13 12:47:01",7.23,0.00,-0.0045,0.0002,-0.2595,-13.33
"RF-TILT-1","2023/06/13 12:53:01",7.23,0.00,-0.0045,0.0001,-0.2595,-13.40
```

6.7 View Data

The downloaded records can be viewed using "View Data" option.

- Press the "VIEW DATA" tab from "Download" screen (figure 6-10 (c)). A window as shown in figure 6-11 (a) will appear.
- Select the desired node from the dropdown.
- Select different parameters from the dropdown to view corresponding data for those parameters..

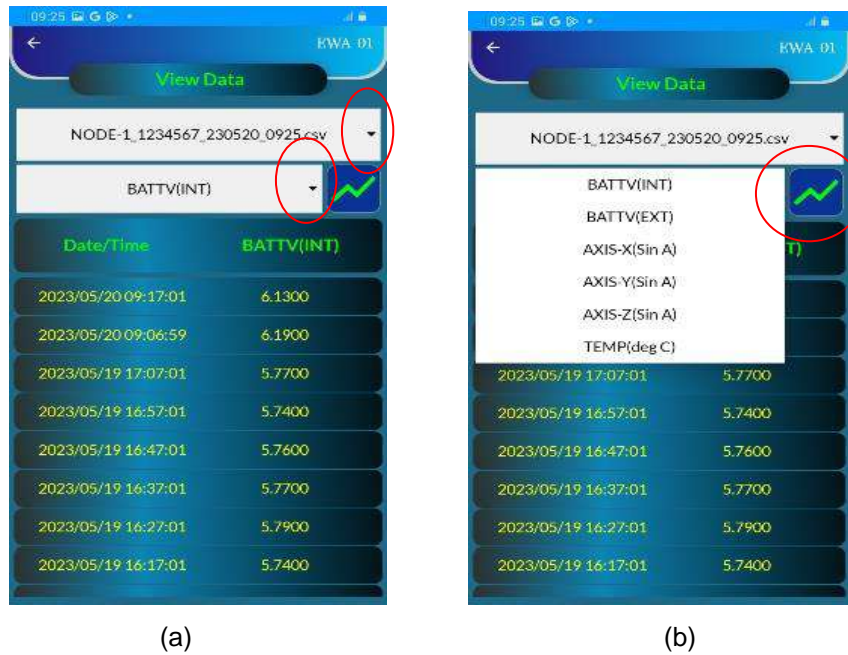

Figure 6-11 View data

- Graph view of selected parameter is also available. Tap the graph button as shown in figure 6-11 (b). A window as shown in the figure 6-12 appears. To view the graph, select Graph Layout, Data Range, X-axis and Y-axis range and click on "OK" button.

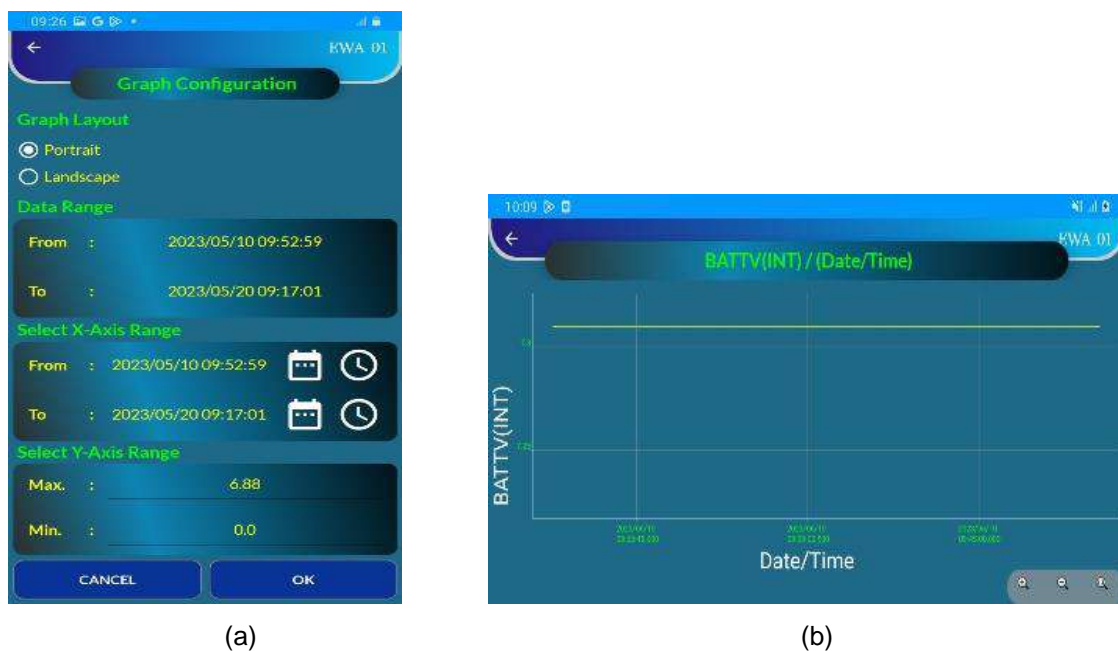
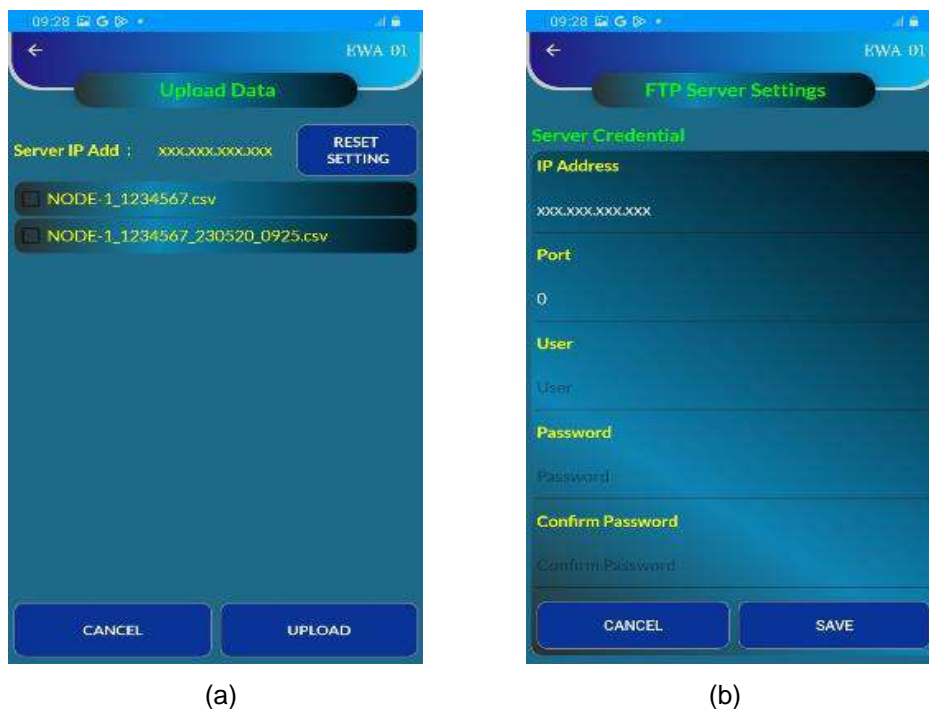

Figure 6-12 View data in graphical format

6.8 Upload File

Data once downloaded on phone can be sent directly to remote FTP server using upload file option.

- Press the “UPLOAD FILE” tab from “Download” screen (figure 6-10 (c)). Screen as shown in figure 6-13 (a) will appear.
- Tap the “Reset Setting” button. Screen as shown in figure 6-13 (b) will appear.
- Enter the FTP credentials correctly and save it.
- Select the file for upload (from screen in figure 6-13 (a)) and click on the “Upload” button to push the file to FTP server. Internet connectivity in the android phone is must to perform this activity.



(a)

(b)

Figure 6-13 Upload data

6.9 Node Diagnostic

Node diagnostic feature is provided to test the RF communication between Node and Gateway. This feature is quite helpful during installation of node.

- Click “NODE DIAGNOSTIC” tab from “Config Node” screen (figure 6-7 (a)). A window as shown in figure 6-14 will appear.
- Check the communication by clicking on the “START TEST” tab.
 - Node will send the test packets to the gateway and display the acknowledgement from gateway.
 - The status of each packet can be seen under test packet status.
 - Other information like RSSI, transmit power could also be seen while testing.
- After successful communication, click on the “STOP TEST” button.

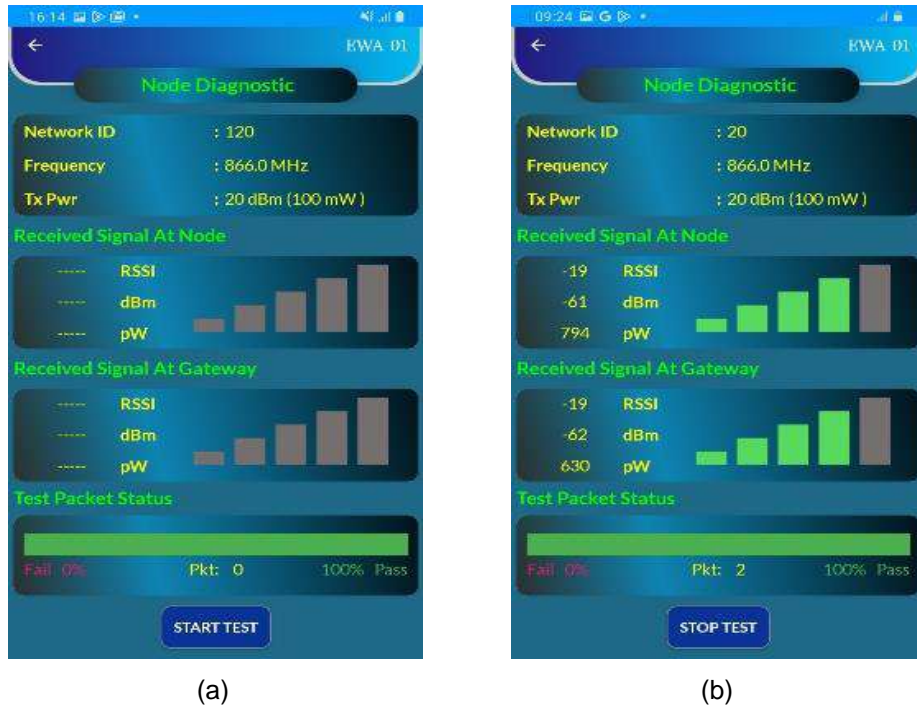

Figure 6-14 Node diagnostic

6.10 Factory Default

Factory default will erase all the user related configuration and data except those configured from factory. Be careful while doing factory reset as data can't be retrieved after this step.

- To reset the node, click on the “FACTORY DEFAULT” tab from “Config Node” screen (figure 6-7 (a)). A prompt window asking for reset password will appear as shown in figure 6-15.
- Enter the password “4TfZ9q7X” and click on the “OK” button to reset the node.

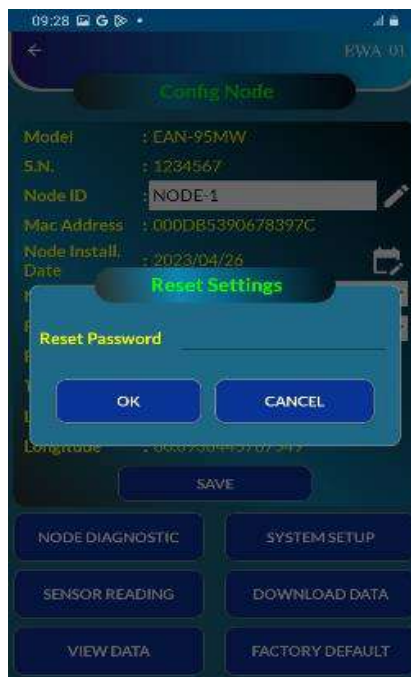

Figure 6-15 Reset settings to factory default

6.11 System Information

System information option provides all the necessary information's about the node.

- Click on the “System Information” tab from the main menu. A window as shown in the figure 6-16 will be displayed. User can click on any tab to see the related information.



Figure 6-16 System information

7 RE-CONFIGURING GATEWAY & NODES AFTER INSTALLATION

7.1 Re-configuring gateway via node

This is the advanced feature where user can configure the gateway in the network from any node in the same network after its installation. It allows users to modify specific gateway parameters. In a network where all nodes are connected to the gateway, users can conveniently configure these parameters from any type of node in the network by connecting it through an Android phone or Laptop.

- Click on the “Config Gateway” tab from the main menu. A window as shown in the figure 7-1 (a) will appear. Screen shows the gateway information and configuration options.

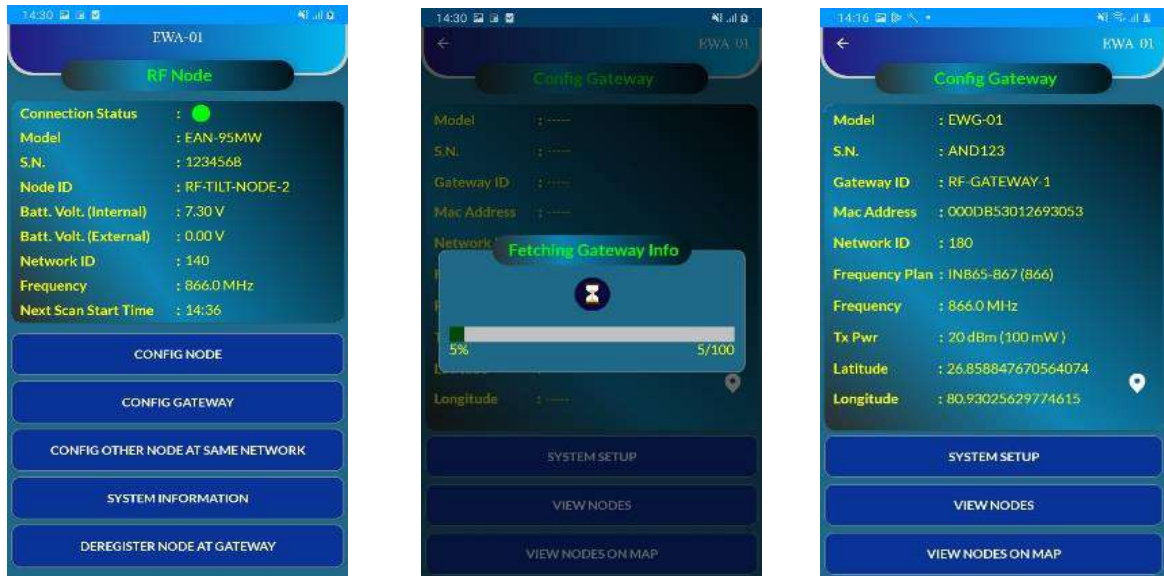

(a)

(b)

(c)

Figure 7-1 Config gateway (via tilt meter node)

- Click on the “System Setup” tab to configure the gateway. Though all the configuration can not be done from Node, but few important parameters like Gateway’s Clock Settings, Scan Start Time, Scan Interval can be modified as shown in figure 7-2 (a).

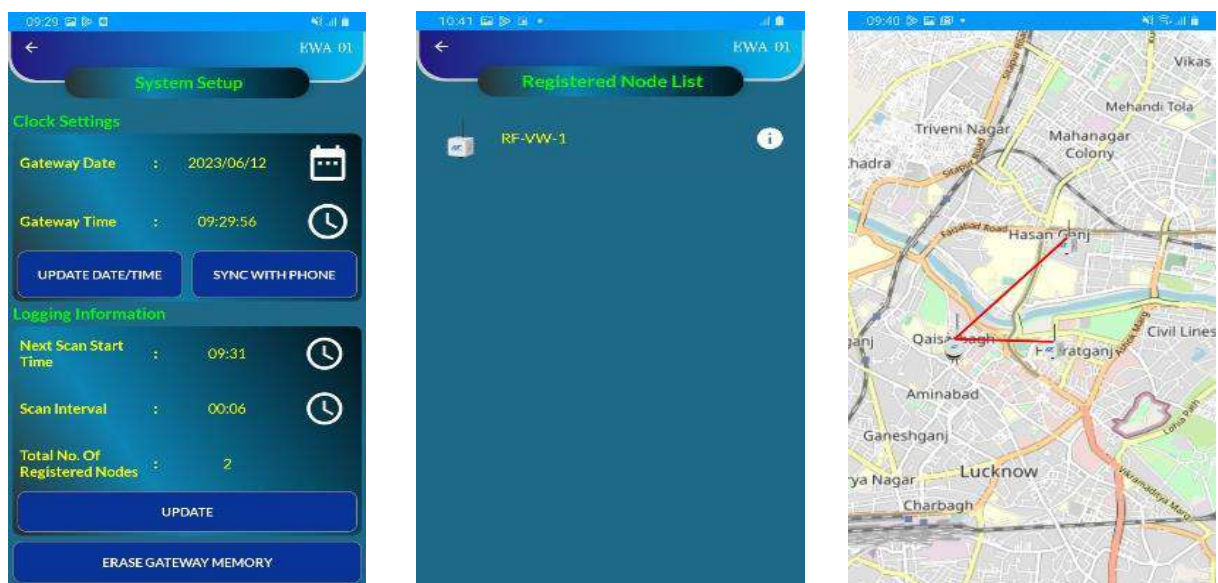

(a)

(b)

(c)

Figure 7-2 View nodes/wireless tilt meters within wireless network

- Gateway's memory can also be erased from this window by selecting "Erase Gateway Memory" tab.
- To view all the nodes connected within the wireless network, click on the "View Nodes" tab from screen shown in figure 7-1 (c). Screen as shown in figure 7-2 (b) will appear.
- To view the connected nodes location on the map, tap on the "View Nodes on Map" tab. Screen as shown in figure 7-2 (c) will appear, with a map showing location of nodes.

7.2 Re-configuring nodes via gateway

With this feature user can perform node-to-node communication and configure any other node, in the same network, from current node.

- Click on the tab "CONFIG NODE" from the main menu. A screen as shown in figure 7-3 (b) will appear.



(a)

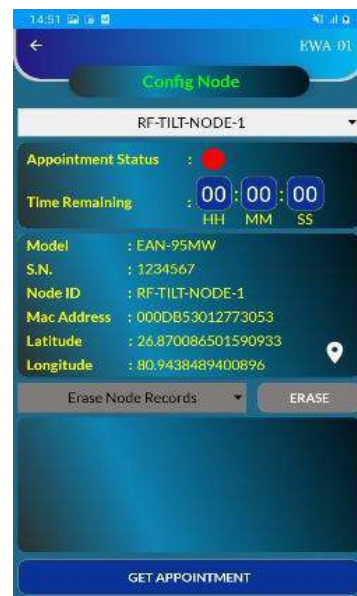

(b)

Figure 7-3

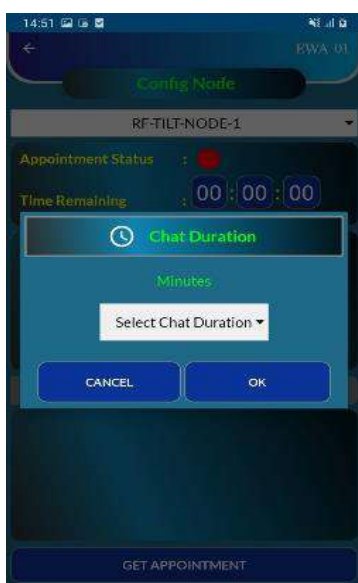

(a)

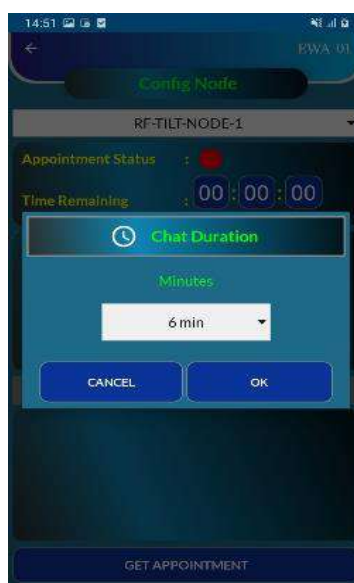

(b)

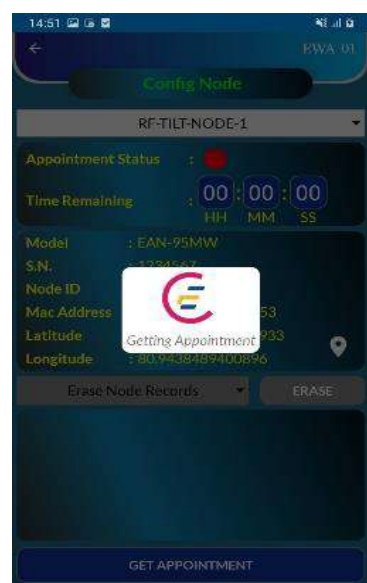

(c)

Figure 7-4

- To configure a specific node, choose the desired node from the dropdown menu,
- Click on the "GET APPOINTMENT" tab to establish a live connection with the chosen node. Please refer to the images in figure 7-4 for detailed instructions on obtaining an appointment from the node.
- Upon successfully raising the appointment request, the screen as shown in figure 7-5 (a) will appear. It will indicate the remaining time until the node becomes live.
- As the appointed time approaches, the appointment status will turn green, as shown in figure 7-5 (b).
- A countdown timer will initiate based on the selected chat duration from the previous step.
- Once the node becomes live, it will be able to respond to the requested commands, as shown in figure 7-5 (c)..



Figure 7-5

- User can cancel the appointment any time by clicking on the Cancel Appointment button.

7.3 Re-configuration other nodes in same network via node

Encardio-rite’s RF wireless system allows even node to configure another node. Below are the steps outlining how to configure the node, using gateway:

- At the home screen click on the “CONFIG OTHER NODE AT SAME NETWORK” tab, as illustrated figure 7-6 (a).
- Allow some time for the node to retrieve information about all the connected nodes in the network. Once this process is complete, screen as shown in 7-6 (b) will appear, presenting the gathered information about the network's connected nodes.

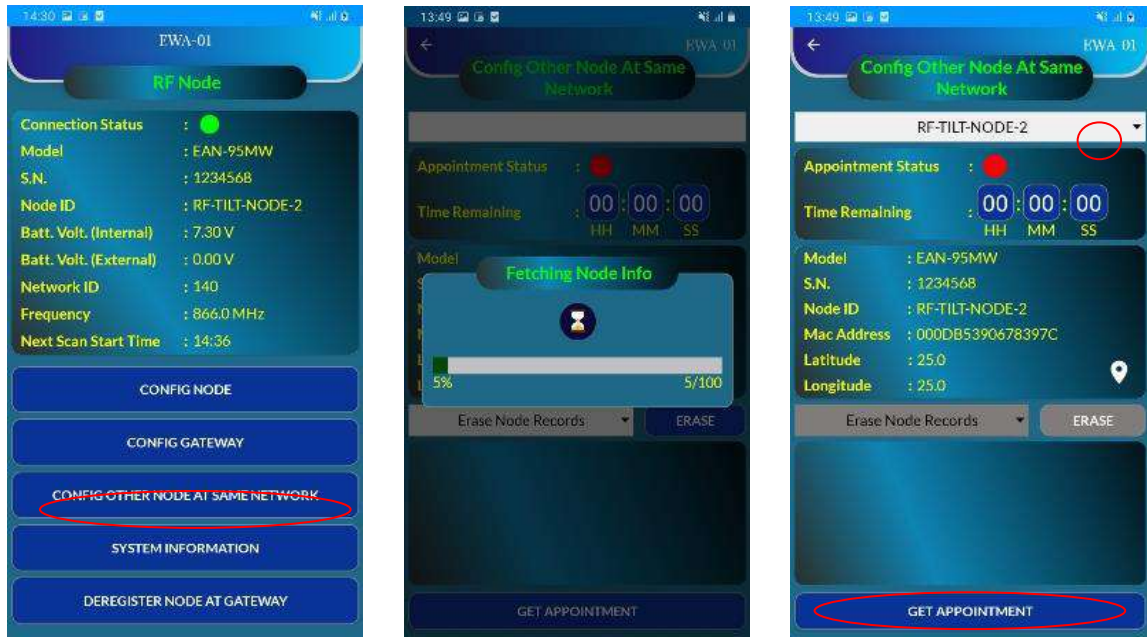

(a) (b) (c)

Figure 7-6

- To configure a specific node, choose the desired node from the dropdown menu, as shown in figure 7-6 (c).
- Click on the "GET APPOINTMENT" tab to establish a live connection with the chosen node. Please refer to the images in figure 7-7 for detailed instructions on obtaining an appointment from the node.

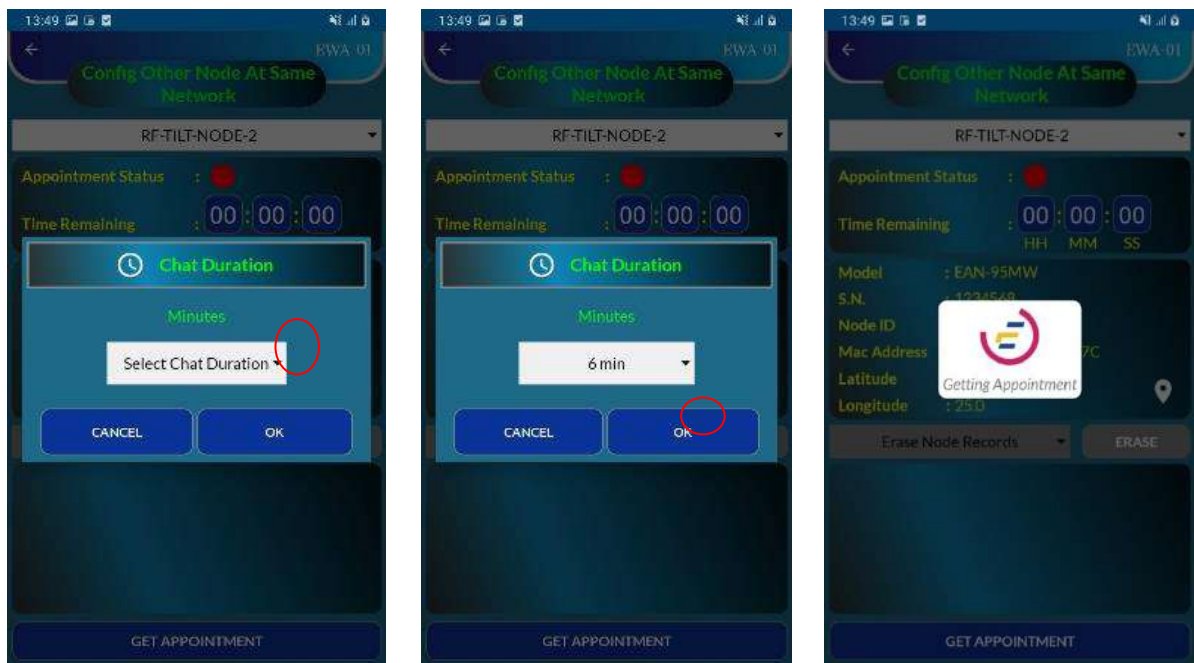

(a) (b) (c)

Figure 7-7

- Upon successfully raising the appointment request, screen as shown in figure 7-8 (a) will appear. It will indicate the remaining time until the node becomes live.
- As the appointed time approaches, the appointment status will turn green, as shown in figure 7-8 (b).

- A countdown timer will initiate based on the selected chat duration from the previous step. Once the node becomes live, it will be able to respond to the requested commands, as shown in figure 7-8 (c).



Figure 7-8

- User can cancel the appointment any time by clicking on the Cancel Appointment button.

8 REGISTER NODE AT GATEWAY

After configuring the node by following all the above steps, it is time to register the node to gateway.

NOTE: While the setting up of tilt meters (nodes) and gateway can be done before installation, registering of the tilt meters to gateway must be done after installation of all tilt meters and gateway (of same network)

- Click on the “Register Node At Gateway” tab from the main menu. While registering, a progress bar will popped up as shown in the figure 8-1 (a) to confirm the process.
- Once the node is registered with the gateway, a prompt window for successful registration will pop-up as shown in the figure 8-1 (b).

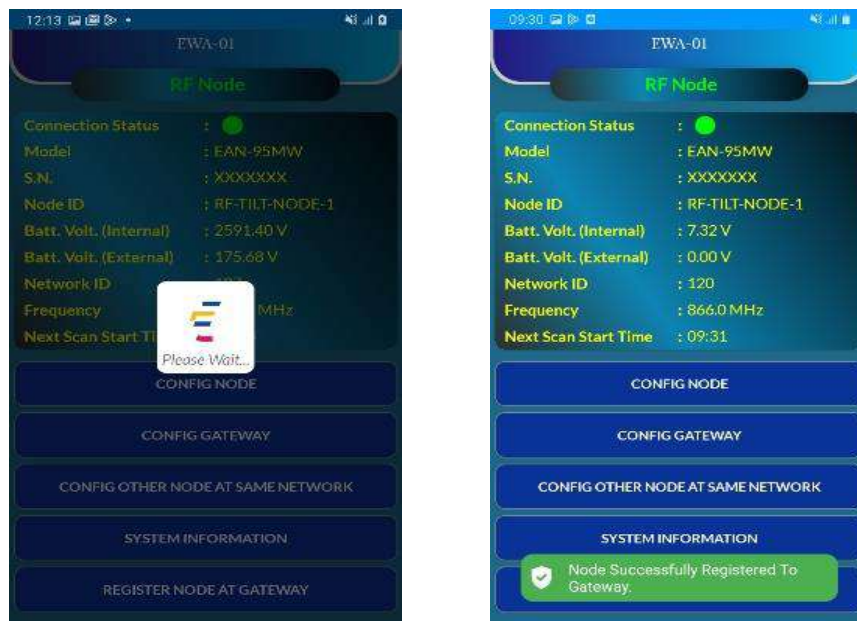

(a)

(b)

Figure 8-1

9 INSTALLATION PROCEDURE

9.1 Tilt meter installation

The model EAN-95MW tilt meter (biaxial) is used to measure rotation of structures in the plane parallel as well as perpendicular to the surface/wall on which the tilt meter is mounted.

The tilt meter can be mounted on a vertical (wall, column, pier, etc) or horizontal plane (floor, ceiling, etc), depending on the application and monitoring requirement.

- Tilt meter enclosure has mounting holes for fixing it on any place surface.

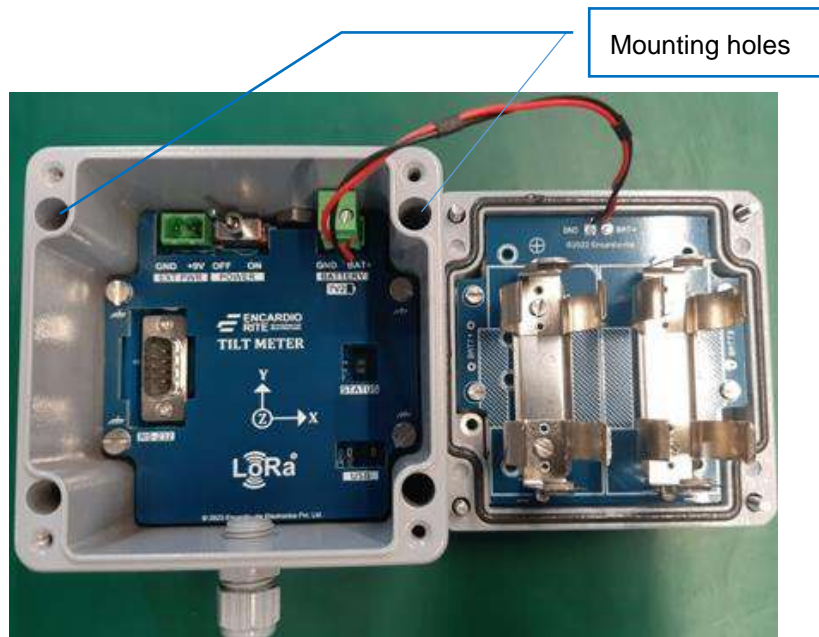

Figure 9-1

- Mark the locations of four mounting holes.
- Ensure that position of the holes are aligned correctly. For vertical mounting, use a spirit level.
- Drill holes depending on the **mounting fasteners** being used for fixing the tilt meter.
- Fix the tilt meter on plane surface. Be careful of the orientation of the tilt meter while mounting on a horizontal or vertical plane. Refer to the section 9.3 for more details.
- After the tilt meter is fixed to the structure, it is adjusted to the zero reading (initial reading). Subtracting the initial tilt reading from the subsequent tilt reading gives change in tilt of structure over a period of time.

CAUTION: Install tilt meter on a structural member of a building and not on the façade or boundary wall which may behave in a different manner than the main building. Do not install it at a location having vibrations, for example caused by heavy rotary machinery. Avoid installing at location where it can be vandalized or get hit by pedestrians.

9.2 Protection of tilt meter

Avoid installation of tilt meter in parts of the structure exposed to direct sunlight. If this is not feasible, a box made from Thermocouple or similar heat insulating material should be installed covering the tilt meter and protecting it from direct sunlight.

If certain degree of mechanical protection is also required, wooden or fiberglass protection boxes may be considered. Heat insulating tape can be fixed to the inner surface of such boxes for thermal insulation.

9.3 Sign convention

Carefully orient the tilt meter during installation.

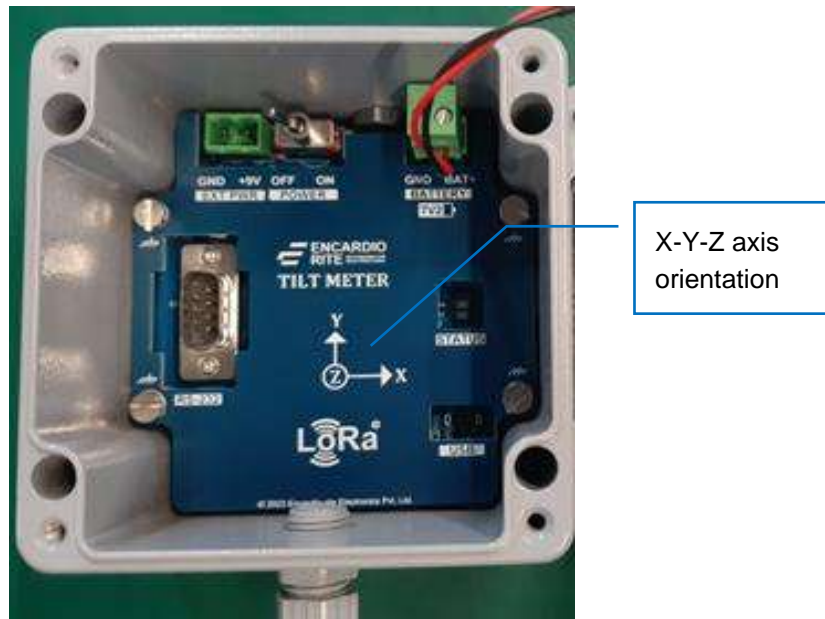

Figure 9-2

9.3.1 Vertical plane

- Movement parallel to plane – Clockwise movement will show increase in X-axis readings (positive sign), while anti-clockwise movement will show decrease in X-axis readings (negative sign)
- Movement perpendicular to plane – Clockwise movement will show increase in Z-axis readings (positive sign), while anti-clockwise movement will show decrease in Z-axis readings (negative sign)

9.3.2 Horizontal plane

- Movement parallel to plane – Clockwise movement will show increase in X-axis readings (positive sign), while anti-clockwise movement will show decrease in X-axis readings (negative sign)
- Movement perpendicular to plane – Clockwise movement will show increase in Y-axis readings (positive sign), while anti-clockwise movement will show decrease in Y-axis readings (negative sign)

9.4 Environmental factors

Several factors can influence the behavior of the structure being monitored for change in tilt using the tilt meter. Having knowledge of the factors influencing the behavior of the structure is essential for analyzing the tilt meter data. Data related to factors such as rain fall, tidal or reservoir levels, excavation or fill levels, construction activities nearby the structure, movement of traffic near the structure and its type, wind, ambient temperature, barometric pressure etc. should also be observed and collected along with the tilt meter data.

10 TROUBLESHOOTING

10.1 Unable to connect Node over Bluetooth

- Android phone's Bluetooth may not be enabled.
- Bluetooth modem may be out of Bluetooth range from android phone.
- Bluetooth modem may not be paired with android phone.
- Check Bluetooth modem baud rate settings. It must be configured for 115200 and hardware flow control should be OFF.
- Turn OFF the Node and then turn ON again.
- Remove the power from node, wait for 30 seconds and then connect the power again. Now try to connect.

10.2 Unable to connect Node with FTDI-OTG Cable

- RS232 interface connector may be loose.
- Check the interface cable's connector for damage.
- RS232 interface cable may be broken.
- Node battery may be discharged.
- Remove the batteries, wait for 30 seconds and then mount the batteries. Now try to connect.

10.3 Unable to communicate with Gateway

- Check the antenna for loose connection.
- Antenna to RF modem connecting cable may be damaged.
- Antenna itself may be damaged try with another antenna.
- Node battery may be discharged.

11 SAFETY AND WARNINGS

11.1 Operation Safety

- Before taking any action, please read the users manual carefully,.
- Ensure that all the procedures and installations are correctly carried out.
- The case and mountings should be grounded, where practicable.
- This product has been designed to meet a certain water-proof level. However, it becomes vulnerable to water ingress when the lid screws are not tightened properly, or if the cable gland has not been sealed properly.
- This product must not be disassembled under any circumstances. If done, it will void the warranty and may leave the product in a dangerous state.

11.2 Battery caution & warning

- To install the battery into a holder, please follow the "+" (positive) and "-" (negative) signs carefully. Wrong orientation of a battery could potential cause unit damage.
- If battery is incorrectly replaced, there may be danger of explosion.
- Use only with the type recommended by the manufacturer. Observe any warnings specified by the battery manufacturer.
- The battery has a relatively high capacity, so please take special care during storage and usage.
- When disposing of the batteries please contact your local authorities or dealer and ask for the correct method of disposal.
- When disconnecting the battery, please take special care not to apply excessive force, otherwise the battery holder and the nearby circuitry can get damaged.

If the above safety precaution and warnings are not followed, the manufacturer cannot be held responsible for any damage and injury caused to the users.